



AutoScan Satellite System #9630

Installation and Operating Instructions



Satellite Solutions for Mobile Markets

5100 W. 36th Street, St. Louis Park, MN 55416
Phone: 800-982-9920 Fax: 952-922-8424

www.kingcontrols.com

IMPORTANT!

The satellite TV market is expanding and changing. The information in this manual was accurate at the time of printing. If your King-Dome does not operate as outlined in this manual please call King Controls at 1-800-982-9920 or visit our website at www.kingcontrols.com.

TABLE OF CONTENTS

Section	Contents	Page
1.	INTRODUCTION.....	2
2.	DEFINITION OF TERMS	3
3.	INSTALLATION	4-10
4.	OPERATION	11-15
5.	STORE/RECALL LOCATIONS	16
6.	DIAGNOSTICS	17
7.	MAINTENANCE	18
8.	LIMITED WARRANTY	19

DIRECTV® is an official trademark of DIRECTV, division of GM Hughes Electronics Corporation.

Dish Network® is an official trademark of Echostar Communications Corporation.

Bell ExpressVu® is an official trademark of Bell Canada.

DVB® is a trademark of the DVB Digital Video Broadcast Project (1991-1996)

The King-Dome AutoScan Satellite System includes 2 main components. (Fig. 1)

Dome (Antenna) Unit	Located on the roof of the vehicle. The dish is covered by a protective dome that keeps operational components free from the elements.
Controller	Located in the vehicle. Used to activate the system, position the dish, and access diagnostic information.

Note: A TV, satellite receiver, and program subscription are also required for satellite TV viewing. (Not supplied by King Controls.)

Fig. 1

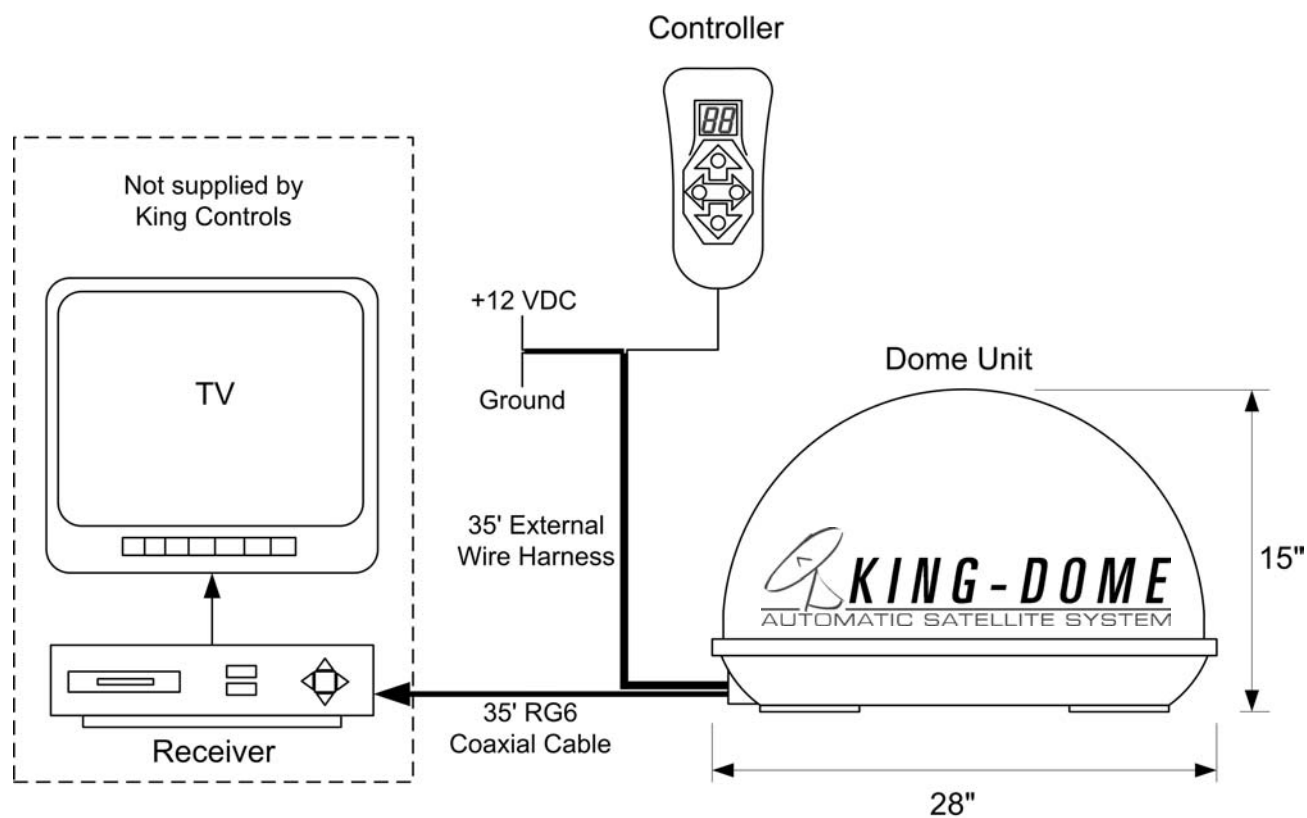

AZIMUTH: Circular rotation around the vehicle.
(like a clock face: front of vehicle is 12:00, rear is 6:00) (Fig. 2)

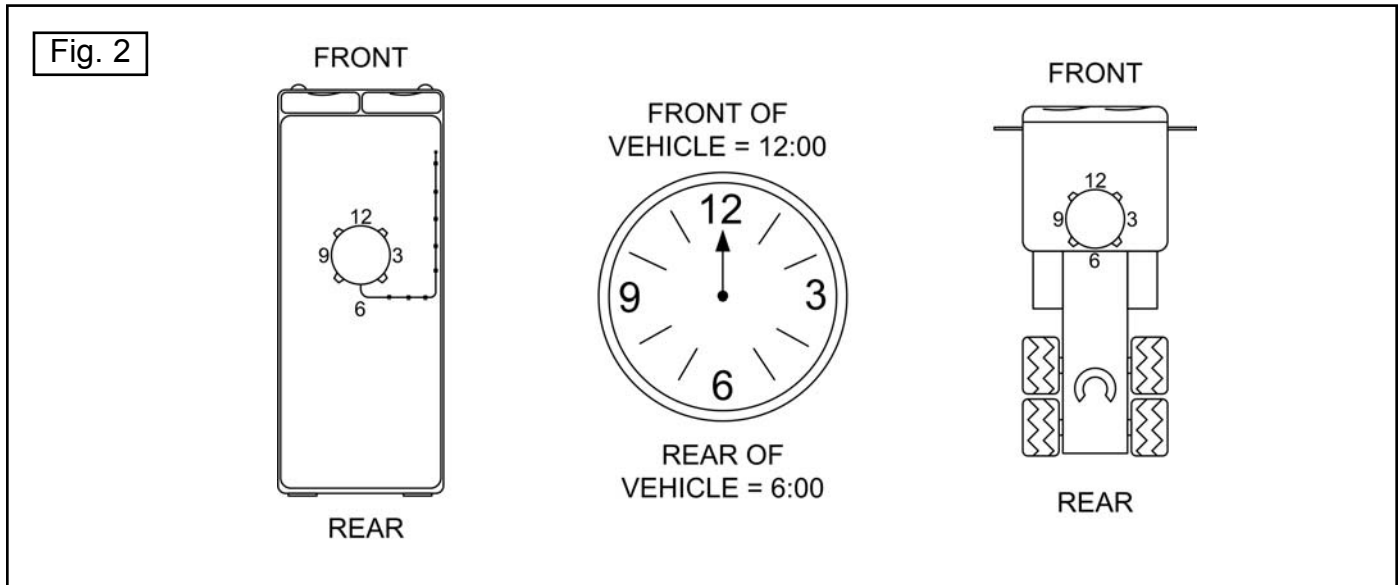

ELEVATION: Angle in degrees measured from the ground plane. (Fig. 3)

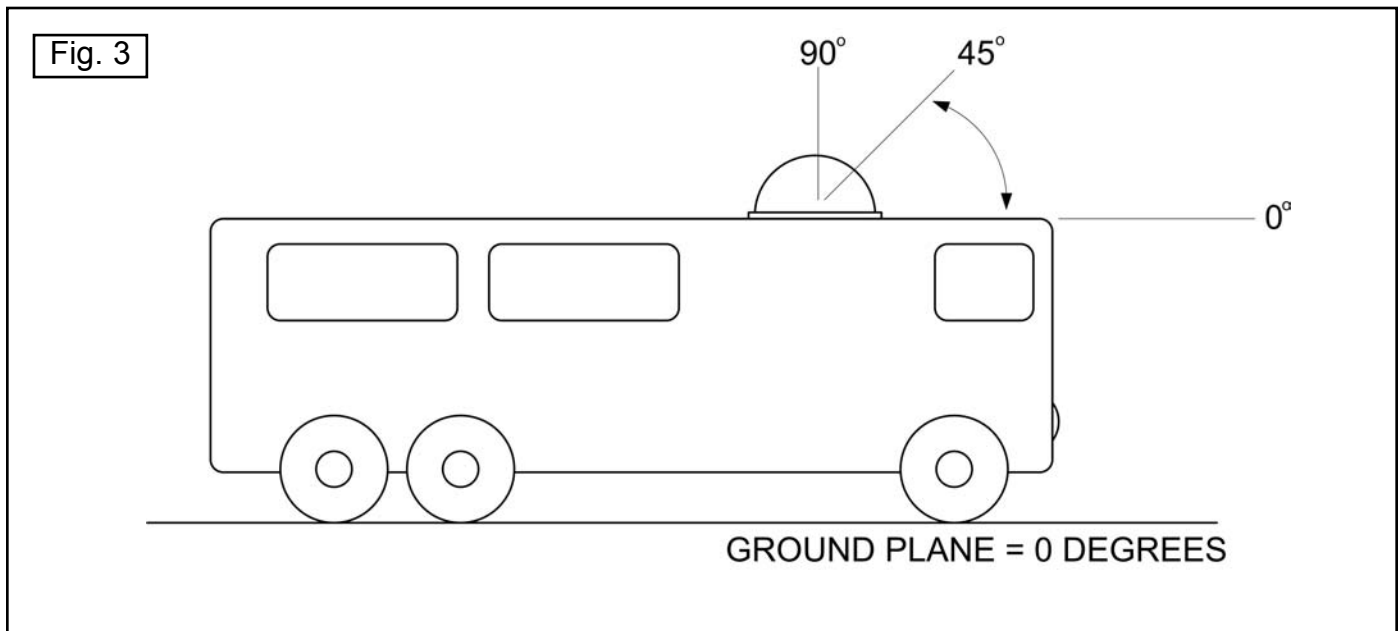

SIGNAL STRENGTH: Intensity of electronic signal received from the satellite transmission.

TOOLS AND MATERIALS REQUIRED:

- drill and drill bit set
- tape measure
- 7/16" open end wrench (coax connections)
- adhesive sealant (compatible with roof material)
- appropriate fasteners to install all components and wiring
- 5/32" allen wrench, channel lock or pliers (to remove shipping bolt)
- wire cutter (to remove shipping tie strap)

KIT CONTENTS:

1. Unpack and identify all components. (Fig. 4)

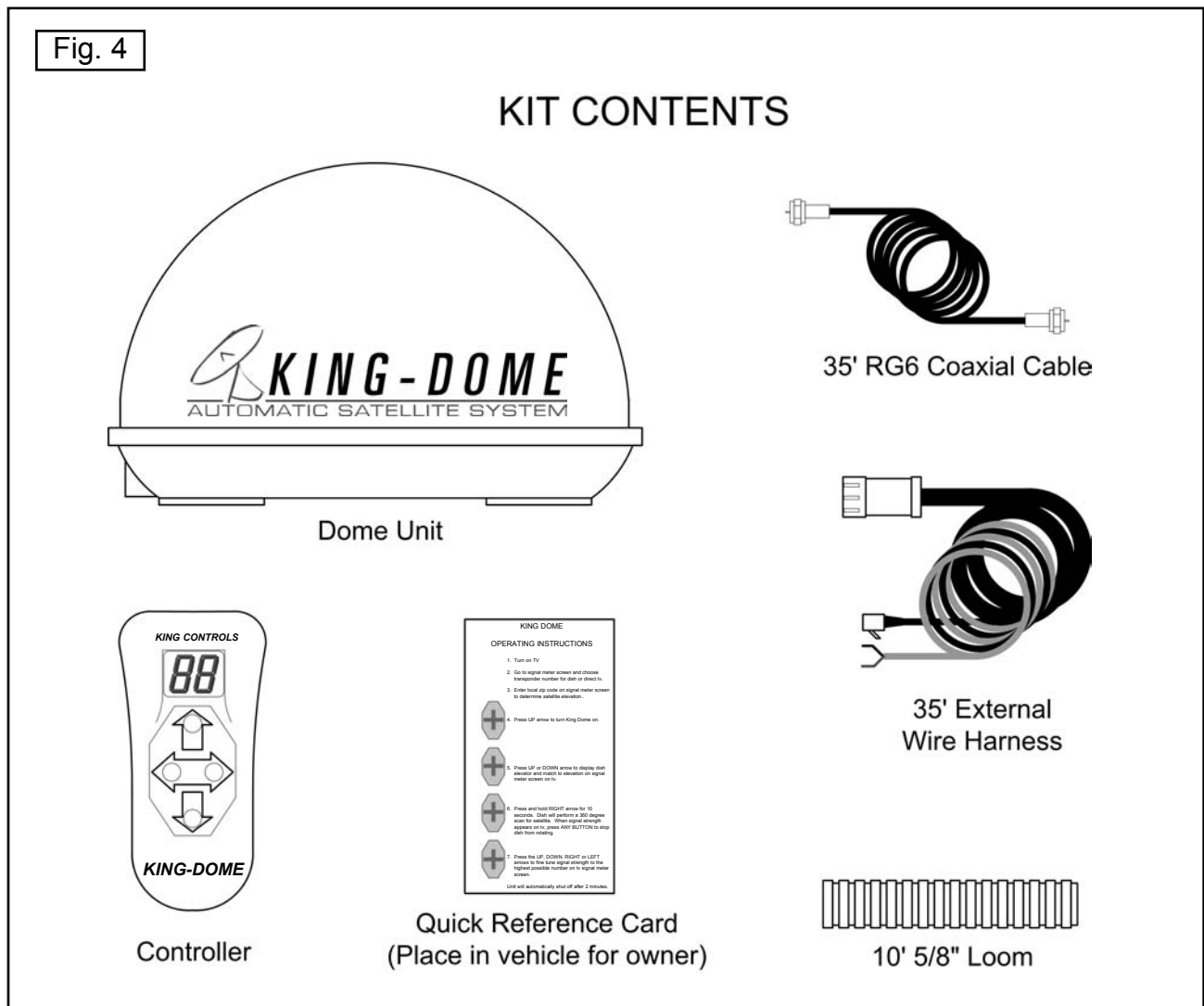

IMPORTANT! The tie strap, bolt and plastic spacers must be removed from the bottom of the dome unit prior to installation. DO NOT REMOVE THE DOME COVER TO REMOVE THESE SHIPPING RESTRAINTS.

2. Remove and discard the tie strap, bolt and plastic spacers that pass through the bottom of the base. (Fig. 5)

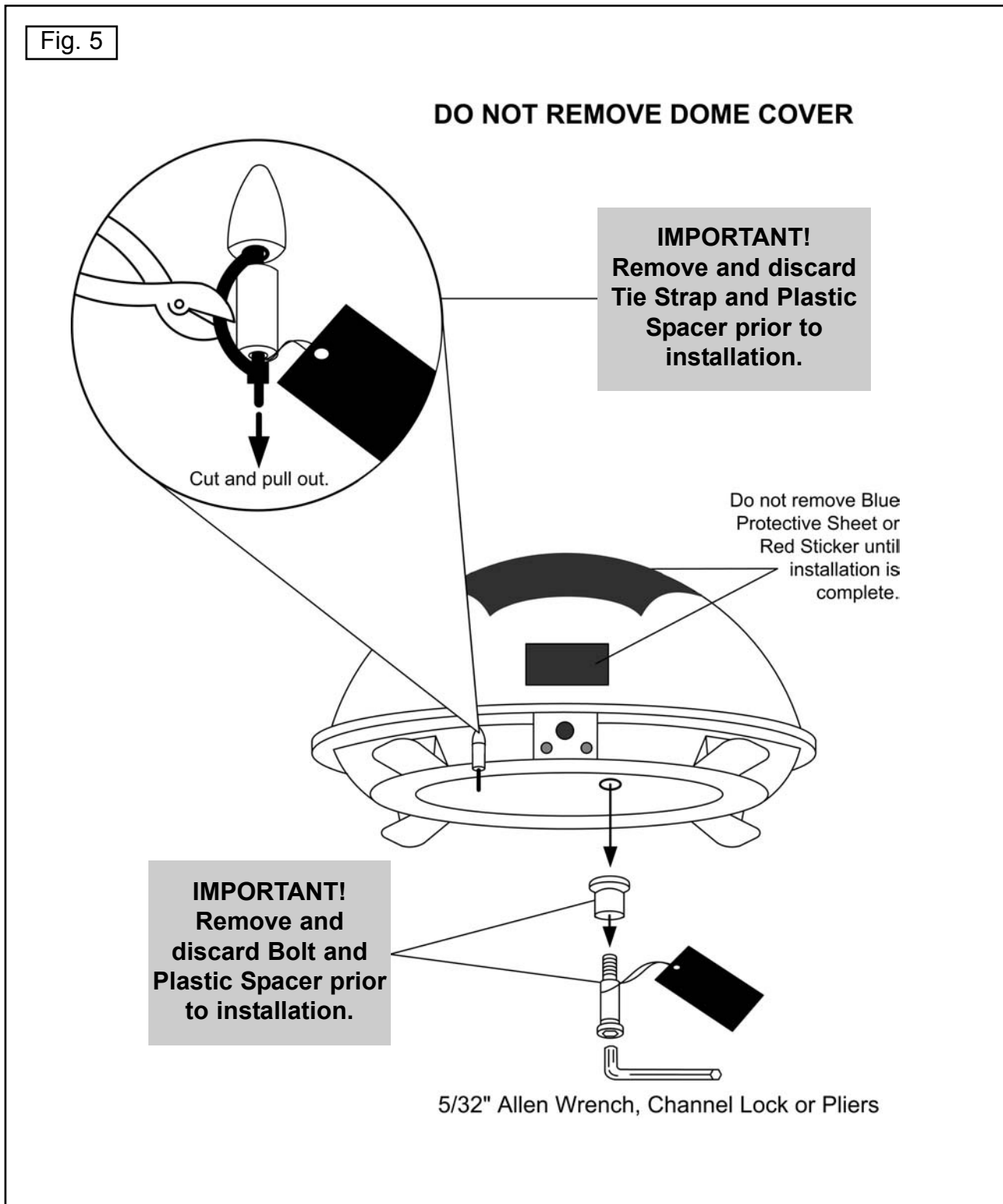

DOME LOCATION

3. Select an area on the roof for the dome unit and the location where the wiring will enter the vehicle through the roof to the satellite receiver, controller, and 12 volt power source inside, using the following criteria:
 - a) The shortest distance between the dome unit and the satellite receiver is most desirable.
 - b) The dome unit requires a 28 inch diameter mounting area.
 - c) The dome unit must be mounted on the centerline of the vehicle. Mounting off centerline reduces electronic level compensation.
 - d) There must be no “line of sight” obstructions. Air conditioning units, other antennas, and storage areas that are too close to the dome unit may prevent the satellite signal from reaching the dish. **(Fig. 6)**

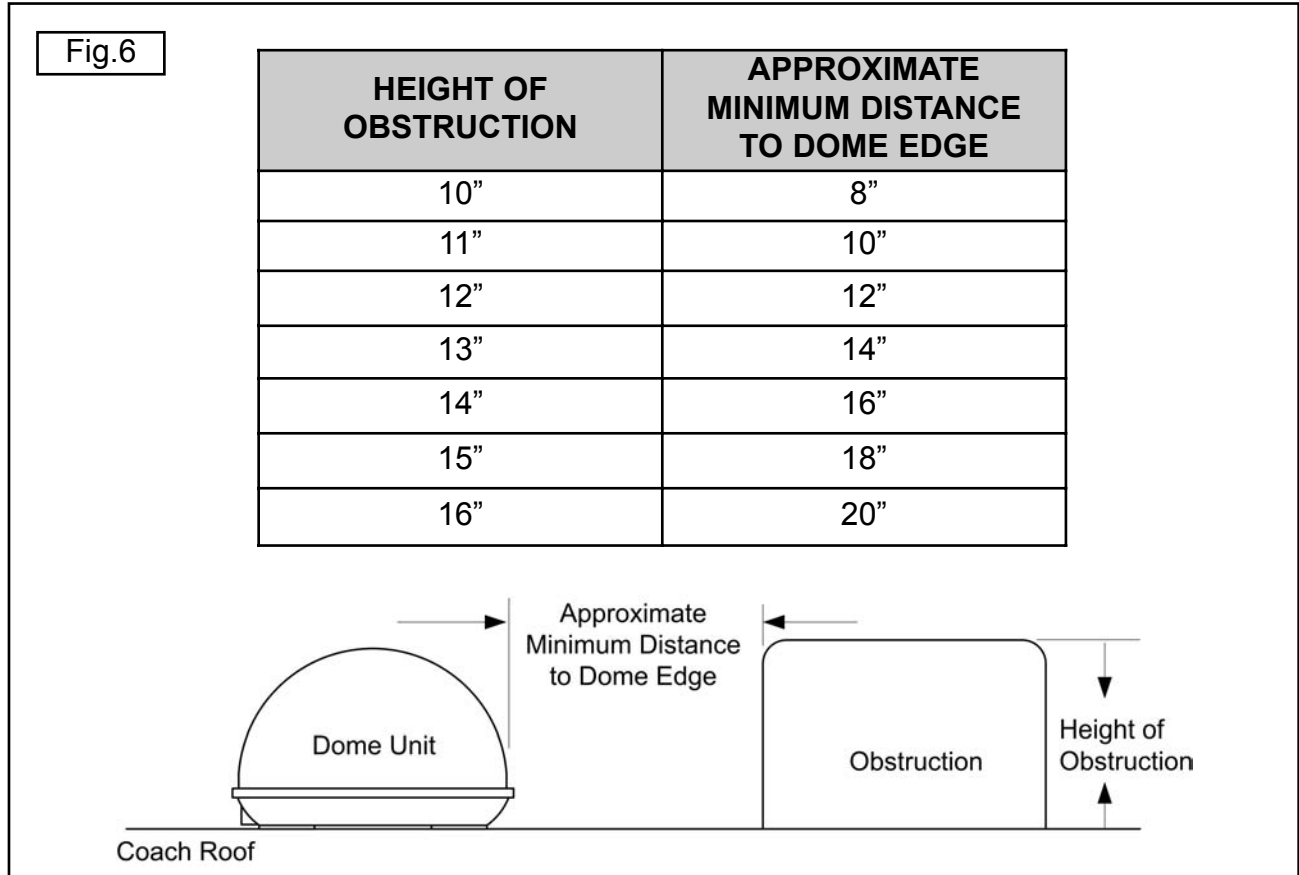

IMPORTANT! For installations on trucks with air shields, a bracket must be used for mounting the dome unit. The dome unit **MUST** be mounted to the air ride cab: **NEVER** to any structure mounted directly to the frame.

See bracket instructions for proper installation. (Fig. 7)

Fig. 7

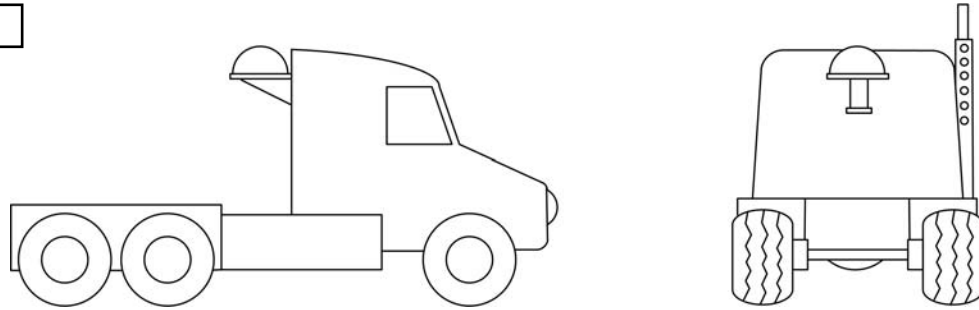

Example of truck installation using bracket.
See bracket instructions for proper installation.

IMPORTANT! The dome unit **MUST** be mounted to the air ride cab: **NEVER** to any structure mounted directly to the frame.

DOME INSTALLATION

IMPORTANT! Make sure shipping restraints are removed from bottom of dome unit. (Fig. 5, Page 5)

Cable connections must **ALWAYS** be positioned facing the rear of vehicle.

- Place dome unit on installation location chosen using the criteria discussed in the previous section. Shipping restraints must be removed (**Fig. 5, Page 5**), and cable connections must **ALWAYS** be positioned facing rear of vehicle.
- The dome unit must be positioned so that both feet on each side of the vehicle are equal distances from the roof edge. This should be checked by measuring the distance from each foot to the roof edge. Confirm that these measurements are equal. (**Fig. 8**)

Fig. 8

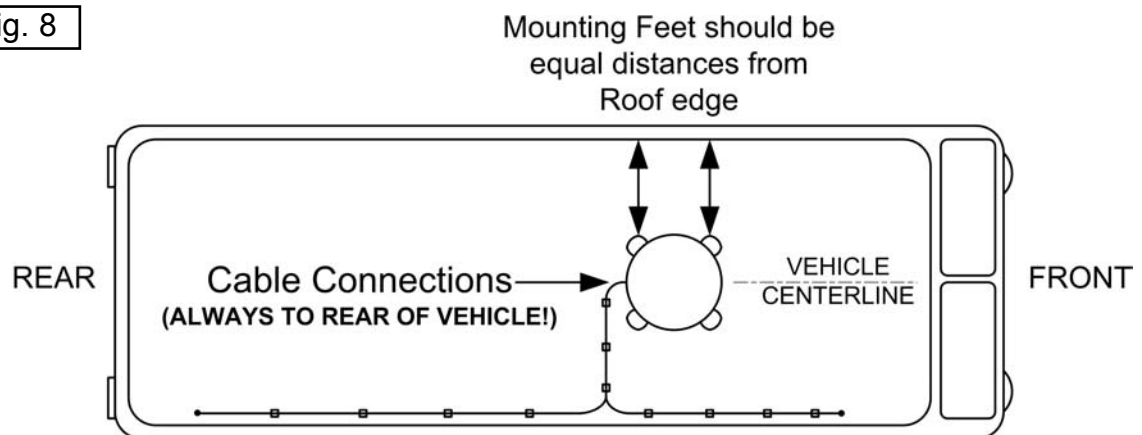

IMPORTANT! The dome should never be mounted so that it is tilted more than 2 degrees in any direction.

Note: The installer is responsible for determining the most appropriate fastener to secure the dome to the roof. Depending on the roof material, fasteners such as lag screws, well nuts, sheet metal screws, toggle bolts and T anchors may be used, and should always be used in combination with a roof compatible sealant.

The installer is responsible for weatherproofing all holes with sealant.

6. Mount the dome unit. Use the pre-drilled holes in the mounting feet as a guide to install the fasteners into the roof. Use additional fasteners whenever necessary.
7. Test that the dome unit is secure by pulling upward from each foot location.

EXTERNAL WIRING

8. Plug external wire harness into wiring port on back of dome unit and tighten connection until it clicks past the detent lock. **(Fig. 9)**

Note: The King-Dome is wired for a dual LNB. There are two coaxial ports on the back of the dome unit. The one labeled “MAIN” **MUST** be connected to the main receiver in vehicle. The one labeled “AUX” can be used for an additional receiver.

9. Connect 35' coax cable to coax port labeled MAIN on back of dome unit and tighten connection. If using a second receiver, connect second 35' coax cable to coax port labeled AUX and tighten connection. Do not over tighten coax connections. **(Fig. 9)**

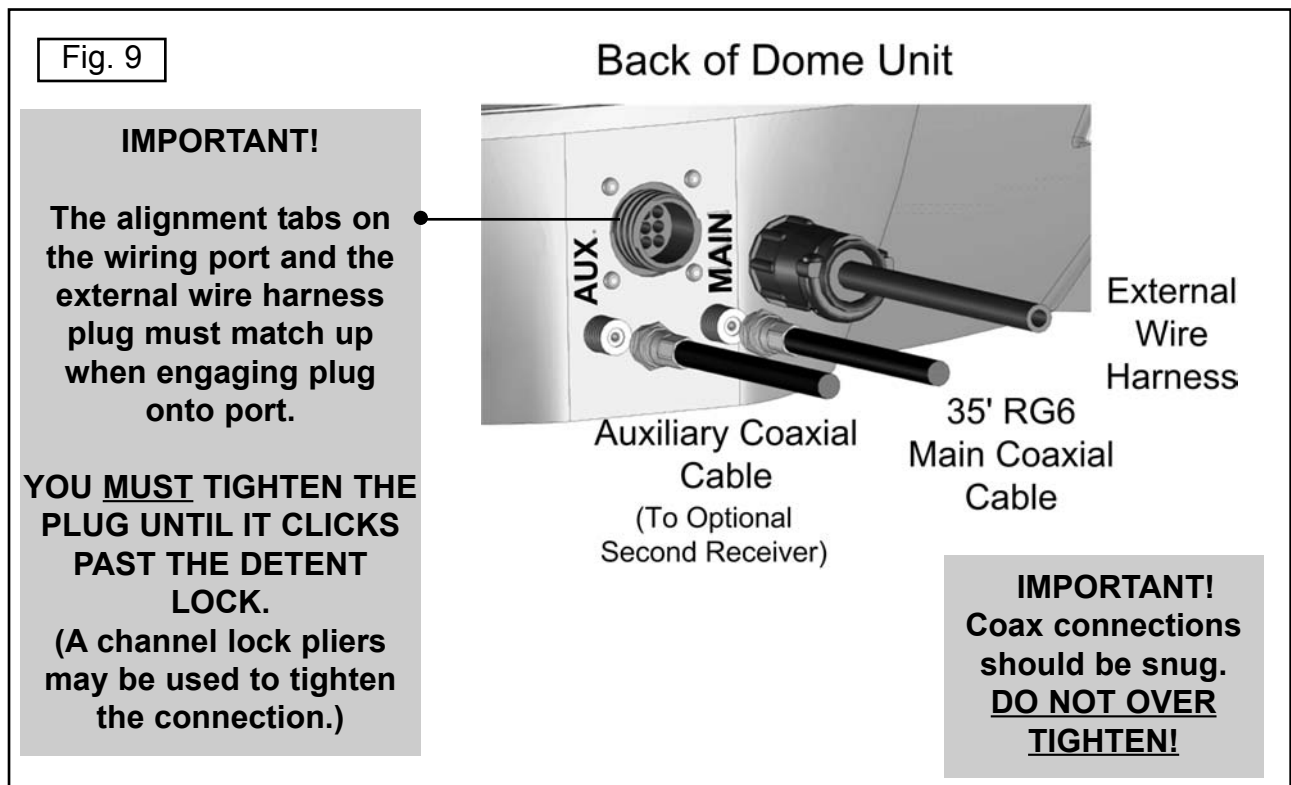

AVOID SHARP BENDS WHEN ROUTING COAX!



NOT CORRECT



CORRECT

10. Run wires from the back of the dome unit to the roof edge, then along edge to location where wiring will be fed into the vehicle. (If installing an optional second receiver, run auxiliary coax to location where it will enter the vehicle.) Secure wiring to roof every 12-18 inches. **(Fig. 10)**
11. Drill 5/8" hole through the roof and into the cabinet where receiver is stored. Feed wiring down through hole. Seal opening with roof compatible sealant so that it is entirely waterproof (inside and outside of the 5/8" hole). Repeat for optional second receiver. **(Fig. 10)**

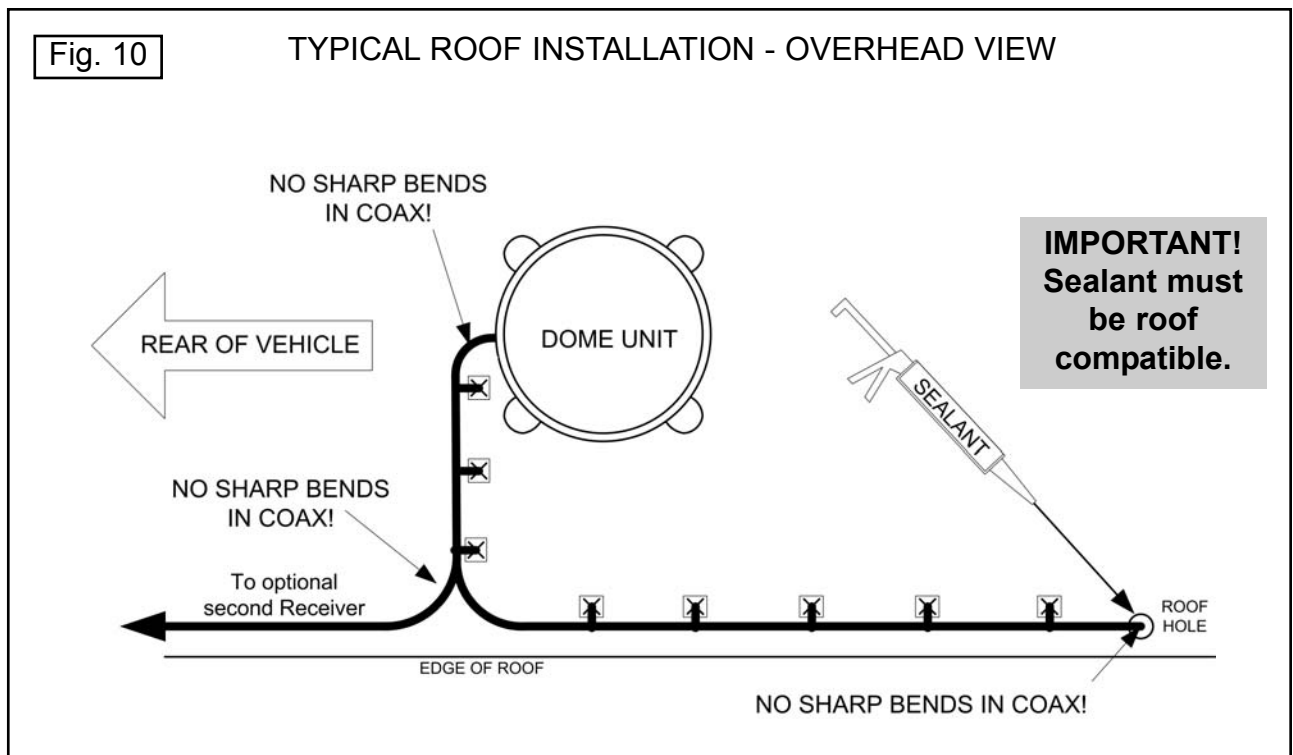

12. Remove blue protective sheet and red "position to rear" sticker from the dome unit.

AVOID SHARP BENDS WHEN ROUTING COAX!



NOT CORRECT



CORRECT

INTERNAL WIRING

IMPORTANT: The connection between the dome unit and the receiver must be a direct connection with no devices in between. Any other devices should be downstream from the receiver.

13. Inside vehicle, connect main coax from the dome unit directly to the “satellite in” port of the main receiver. Do not go through an “A-B” or any other switch, box, or booster. Connect auxiliary coax directly to optional second receiver.

IMPORTANT: Power connection must be a non-shared circuit. Excessive current draw on the circuit will cause the unit to operate improperly. Power and ground connections must be made after the wires are connected to the dome unit.

14. Connect red and black two conductor wire to a power source and ground. Red connects to +12 volts, and black connects to ground.
15. Plug phone style Controller Cable into Controller.

IMPORTANT! There must be a clear “line of sight” to the southern sky. Mountains, buildings, trees, telephone poles, etc. can all block the satellite signal from reaching the dish.

1. Turn TV and satellite receiver on.
2. Go to the signal meter screen on TV.
Choose transponder number: **Dish Network #19**
DirecTV #02
3. Enter local ZIP code on signal meter screen to determine satellite elevation. If you do not know your local zip code, determine your elevation from the maps on pages 12-14.

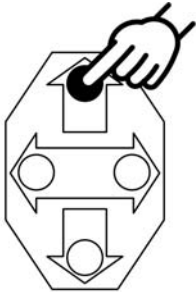

4. Press **UP** arrow on King-Dome Controller to turn King-Dome on.

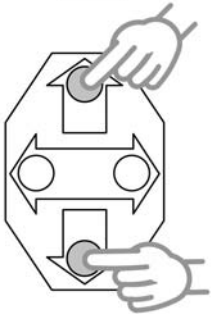

5. Press **UP** or **DOWN** arrow on King-Dome Controller to display dish elevation and match to elevation on TV signal meter screen or elevation from maps on pages 12-14.

IMPORTANT! During Step 6, continuously monitor TV signal meter screen until signal appears on TV.

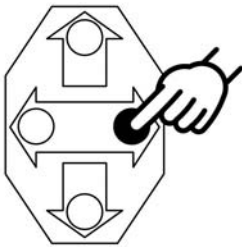

6. Press and hold **RIGHT** arrow until King-Dome controller begins flashing “77”. Dish will automatically perform a 360 degree scan for satellite. When signal strength appears on TV, press **ANY BUTTON** to stop the dish from rotating.

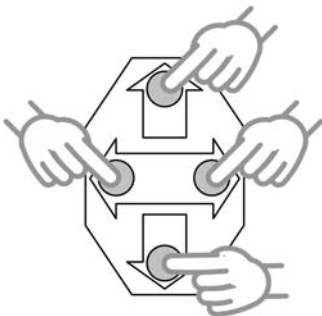

7. Press the **UP, DOWN, LEFT** or **RIGHT** arrows to fine tune signal strength to the highest possible number on TV signal meter screen. Enjoy your programming!

Controller automatically shuts off after 2 minutes.

Elevation Map for DIRECTV 101

Find your location on the map. Use the elevation lines to determine your approximate elevation.

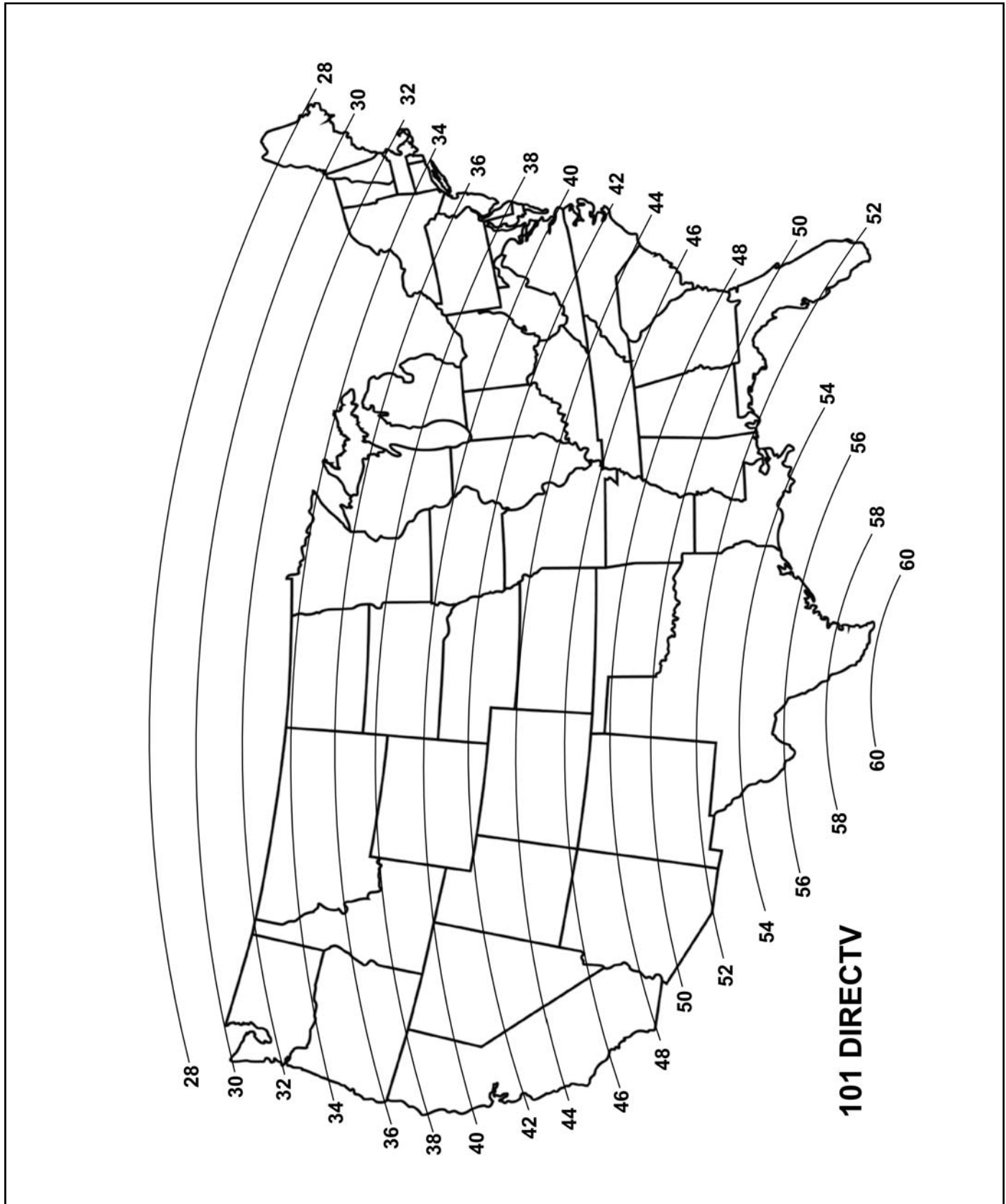

Elevation Map for Dish Network 110

Find your location on the map. Use the elevation lines to determine your approximate elevation.

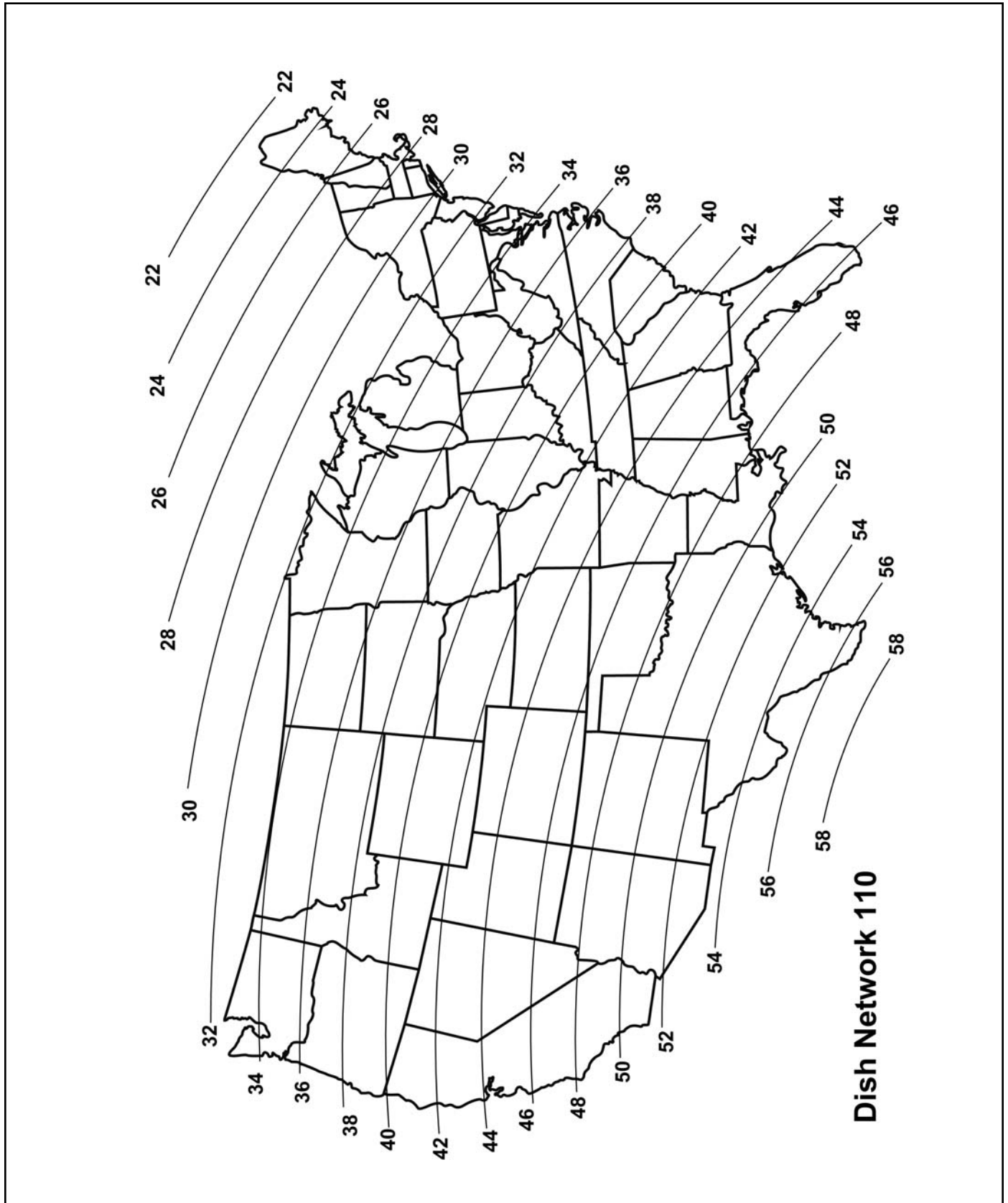

Elevation Map for Dish Network 119

Find your location on the map. Use the elevation lines to determine your approximate elevation.

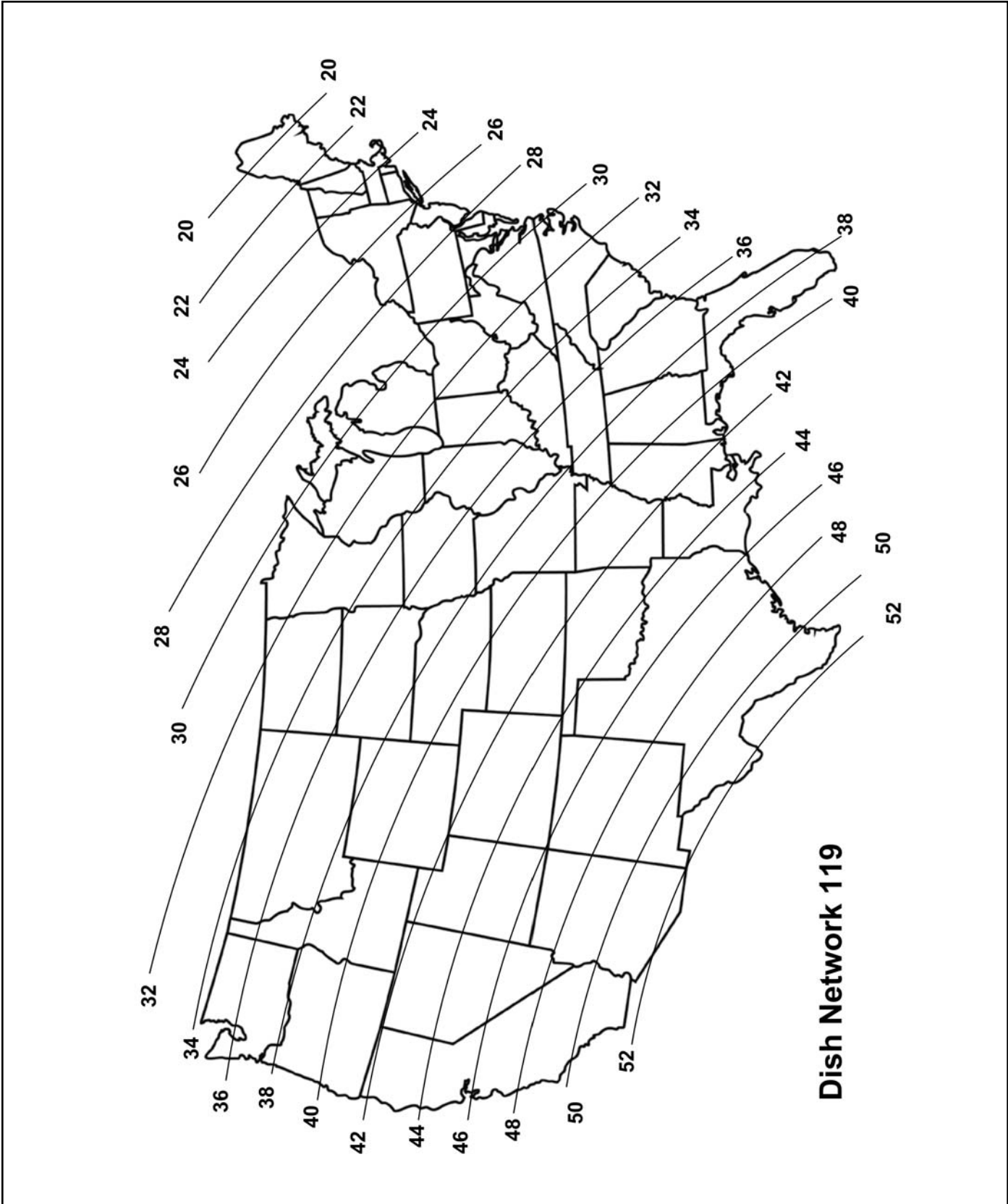

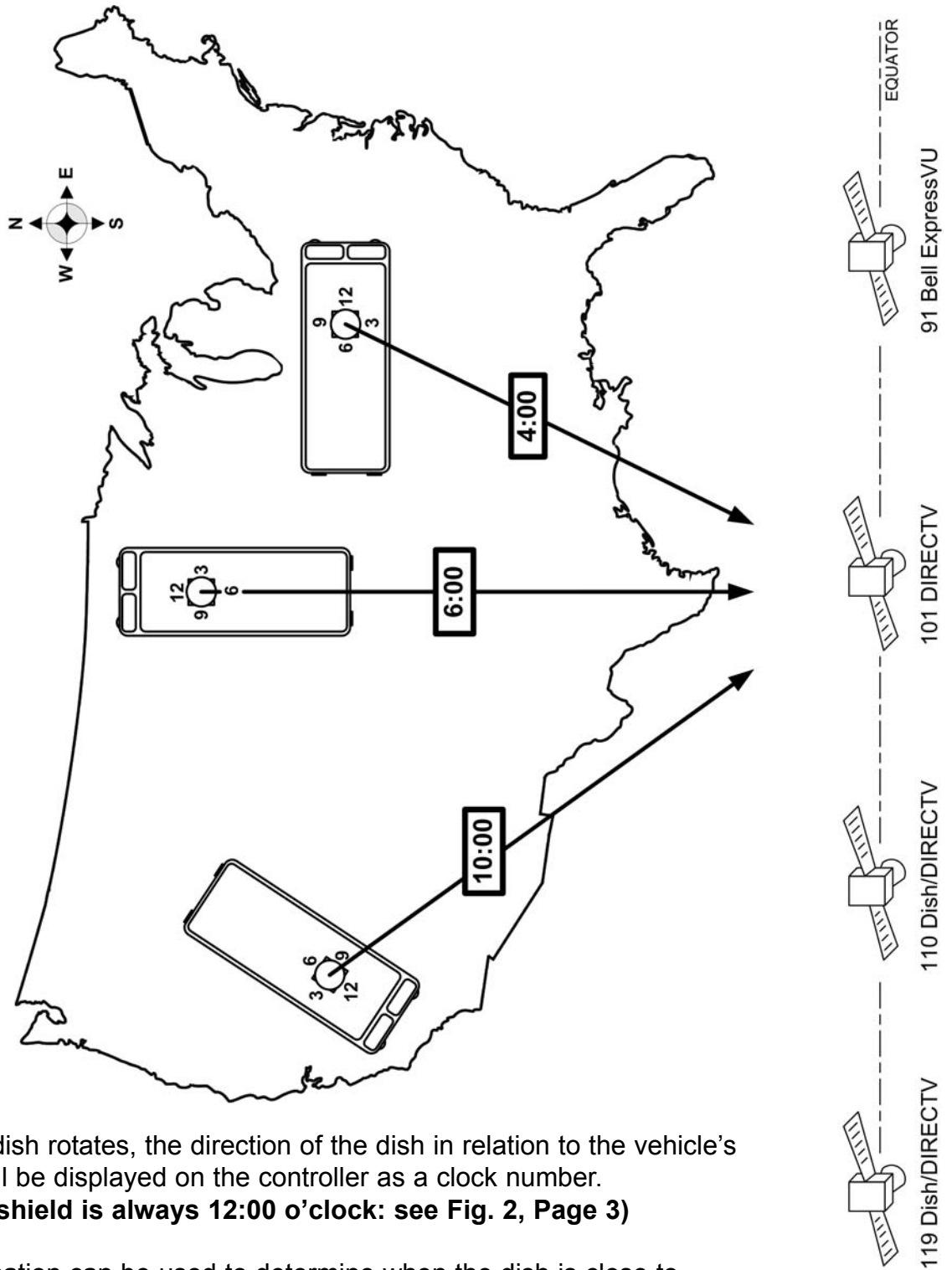

While the dish rotates, the direction of the dish in relation to the vehicle's position will be displayed on the controller as a clock number.
(The windshield is always 12:00 o'clock: see Fig. 2, Page 3)

This information can be used to determine when the dish is close to pointing at the desired satellite.

IMPORTANT! You must continuously monitor the TV for signal strength while the dish is rotating. DO NOT WATCH THE KING-DOME CONTROLLER.

Note: For use with multi-satellite services. (such as Dish 500)

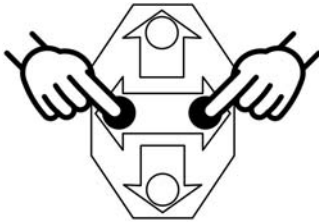
Store Satellite Location #1

1. Once locked onto a desired satellite, hold **LEFT AND RIGHT** arrows simultaneously until display flashes.

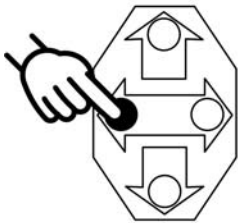

2. Hold **LEFT** arrow until **OH** appears on display.
Location #1 is stored in memory for this location.

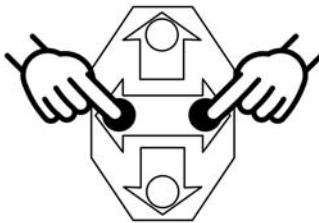
Store Satellite Location #2

3. Once locked onto the second desired satellite, hold **LEFT AND RIGHT** arrows simultaneously until display flashes.

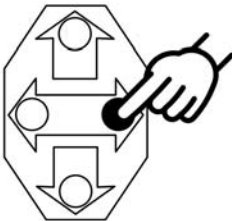

4. Hold **RIGHT** arrow until **OH** appears on display.
Location #2 is stored in memory for this location.

Recall Satellite Location #1

5. Press **DOWN AND LEFT** arrows simultaneously.
Dish will automatically move to Satellite Location #1.

Recall Satellite Location #2

6. Press **DOWN AND RIGHT** arrows simultaneously.
Dish will automatically move to Satellite Location #2.

To check Coaxial Cable Connection: Press **UP AND LEFT** arrows simultaneously

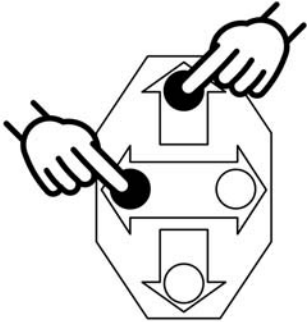

1E = Receiver is not connected or bad coax connection

H or L = Proper coax connection

To check Supply Voltage: Press **UP AND RIGHT** arrows simultaneously

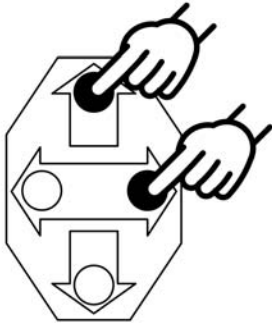

Example: When Display flashes:

BLANK	then	92 = 9.2 volts
1	then	00 = 10.0 volts
1	then	20 = 12.0 volts
1	then	36 = 13.6 volts

When Display quickly flashes:

1L - 08 = Clockwise rotational limit reached

2L - 08 = Counterclockwise rotational limit reached

The King-Dome Satellite System has been designed to be maintenance and trouble free.

For optimum signal strength, keep the dome clean from dirt, bugs, and other debris. Periodic washing of the dome with mild soap and water is recommended.

If you plan on storing your vehicle for long periods of time, it is recommended that the system be put through a search procedure on a quarterly basis to keep all moving parts in good working order.

If you have any comments or questions, please contact the King Controls Service Department at 1-800-982-9920, or email King Controls at info@kingcontrols.com

Every King Controls Satellite System is thoroughly inspected and tested before leaving the factory. It is covered by a two year parts and one year labor limited warranty from the date of original purchase. This warranty does not cover installation and external wiring or refurbished units.

Should any trouble develop during the warranty period, contact King Controls or one of its certified dealers. Only King Controls and certified dealers are authorized to perform warranty evaluations and repairs.

If it is determined that the unit needs to be returned, return COMPLETE product, freight prepaid, to : **King Controls, 5100 West 36th Street, St. Louis Park, MN 55416**. If inspection shows the trouble is caused by defective workmanship or material, King Controls will repair (or at its option, replace) without charge.

This warranty does not apply where:

- The product has been abused, misused, improperly installed or improperly maintained.
- Repairs have been made or attempted by others that are not certified by King Controls to do such repairs.
- Repairs are required because of normal wear and tear.
- Alterations have been made to the product.

In no event shall King Controls be liable for any indirect, incidental, or consequential damages from the sale or use of the product. This disclaimer applies both during and after the term of the warranty.

King Controls disclaims liability for any implied warranties, including implied warranties of "merchantability" and "fitness for a specific purpose," after the one year term of this warranty.

This warranty gives you specific legal rights, and you may also have other rights, which vary from state to state. Some states do not allow the exclusion or limitation of incidental or consequential damages, so the above limitation or exclusion may not apply to you. Some states do not allow limitations on how long an implied warranty lasts, so the above limitation may not apply to you.



5100 W. 36th Street, St. Louis Park, MN 55416
Phone: 800-982-9920 Fax: 952-922-8424

www.kingcontrols.com

